

MQF576 Series Temperature Compensated Crystal Oscillators (TCXOs)
VMQF576 Series TCXO with Voltage Control Function (VCTCXOs)

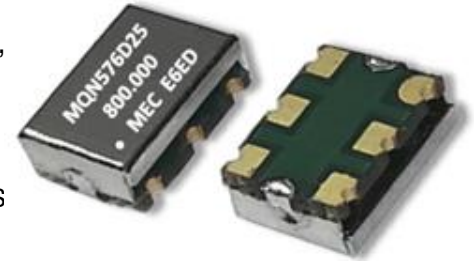

MERCURY
Since 1973

MQF576 and **VMQF576** are 7.0 x 5.0 x 2.5 mm SMD LVPECL or LVDS output TCXOs and VCTCXOs, available in either 2.5 V or 3.3 V supply voltage, frequency up to 1.5 GHz. The product flexibility makes the custom (VC)TCXO frequencies more readily available than any other series, with a short lead time. The 0.8 ~ 1.6 ps typical phase jitter and lower current consumption (43 mA typical for LVPECL 622.080 MHz at 3.3 V) compared to competitions make the series ideal for multimedia, Ethernet, and networking applications.



Relevant Categories:

- **QMQF576** and **QVMQF576** are QuikXO™ (quick-turn delivery) versions of the MQF576 and VMQF576 series respectively. QuikXO™ products, either standard or custom frequencies, are produced and shipped from California USA in 3 to 5 days. Click to check our inventory and place your order online.
- For lower phase noise and phase jitter (0.6 p. sec. typical), please refer to **MQN576** and **VMQN576** series.
- For 3.2 x 2.5 x 1.6 mm 6-pad SMD with the same electrical performance, please refer to the **MQF326**, **VMQF326** series.

General Specifications: at Ta= +25°C

Output Logic Type	LVPECL (code "P")		LVDS (code "D")	
TCXO Models	MQF576P25	MQF576P33	MQF576D25	MQF576D33
VCTCXO Models	VMQF576P25	VMQF576P33	VMQF576D25	VMQF576D33
Frequency Range	10 ~ 1500 MHz		10 ~ 1500 MHz	
Supply Voltage (V _{DD})	+2.5 V ±5%	+3.3 V ±5%	+2.5 V ±5%	+3.3 V ±5%
	Code "25"	Code "33"	Code "25"	Code "33"
Current Consumption (mA; typical)	18 MHz: 28	18 MHz: 35	11 MHz: 19	11 MHz: 22
	156 MHz: 30	156 MHz: 38	190 MHz: 23	155.5 MHz: 26
	622 MHz: 33	622 MHz: 43	390 MHz: 24	250 MHz: 28
	1289 MHz: 37	1289 MHz: 51	1289 MHz: 31	1080 MHz: 32
	1500 MHz: 43	1500 MHz: 52	1500 MHz: 34	1500 MHz: 35
Load; typical	50 Ω into V _{CC} - 2.0 V or Thevenin equivalent		100 Ω across the outputs	
Output "High" Voltage; (V _{OH})	V _{DD} -1.03 V min.; V _{DD} -0.6 V max.		1.4 V typical; 1.6 V max.	
Output "Low" Voltage; V _{OL}	V _{DD} -1.85 V min.; V _{DD} -1.6 V max		1.1 V typical; 0.9 V min.	
Rise Time (Tr) / Fall Time (Tf)	0.2 nS Typ.; 0.5 nS max. (20% ↔ 80% waveform)		0.2 nS Typ.; 0.4 nS max. (20% ↔ 80% waveform)	



MERCURY www.mercury-crystal.com

Taiwan: TEL (886)-2-2406-2779, e-mail: sales-tw@mercury-crystal.com

U.S.A.: TEL (1)-909-466-0427, e-mail: sales-us@MercuryUnited.com

Additional Output AC Characteristics for LVDS output (LVDS only)	Differential Output Voltage (V_{OD}): 175 mV min.; 350 mV typical V_{OD} Magnitude Change (ΔV_{OD}): 50 mV max. Offset Voltage (V_{OS}): 1.25 V typical V_{OS} Magnitude Change (ΔV_{OS}): 50 mV max.											
Frequency Stability	Stability Temperature	± 0.5 ppm	± 1.0 ppm	± 1.5 ppm	± 2.0 ppm	± 2.5 ppm						
	0 to +55°C	Available	Available	Available	Available	Available						
	-10 to +60°C	Available	Available	Available	Available	Available						
	-20 to +70°C	Available	Available	Available	Available	Available						
	-30 to +85°C	Contact Mercury	Available	Available	Available	Available						
	-40 to +85°C	Contact Mercury	Available	Available	Available	Available						
	Voltage Change	± 0.2 ppm max. for a $\pm 5\%$ input voltage change										
	Load Change	± 0.2 ppm max. for a $\pm 10\%$ load condition change										
	Aging at $T_a = +25^\circ\text{C}$	± 2 ppm max. first-year; ± 10 ppm max. over 10 years										
Reflow	± 1.0 ppm max., one reflow and measured 24 hours afterward.											
Initial Calibration Tolerance (Initial Frequency Accuracy)	± 1.0 ppm typical; ± 2.0 ppm max. at $+25^\circ\text{C} \pm 2^\circ\text{C}$.											
Duty Cycle	50% $\pm 5\%$. At 50% V_{DD} .											
Current with Output Disabled	18 mA typical											
Start-up Time	5 m. sec. max.											
Output Enable Time	200 ns max.											
Output Disable Time	50 ns max.											
Single Side-band Phase Noise (dBc/Hz; typical)	Frequency (MHz)	25	49.152	50	100	156.250	600	1030	1080	1270	1450	
	Supply Voltage	3.3	3.3	3.3	3.3	3.3	3.3	3.3	3.3	3.3	3.3	
	Output Logic	P	D	D	D	P	P	P	D	D	D	
	Offset	10 Hz	-61	-85	-80	-73	-63	-59	-53	-49	-49	-52
		100 Hz	-106	-108	-103	-96	-91	-81	-75	-81	-78	-78
		1 kHz	-125	-121	-117	-109	-109	-96	-93	-93	-91	-89
		10 kHz	-132	-126	-124	-119	-115	-102	-94	-98	-94	-92
		100 kHz	-133	-127	-127	-120	-116	-104	-97	-99	-97	-94
		1 MHz	-151	-146	-145	-138	-137	-125	-119	-120	-117	-118
		5 MHz	-153	-154	-148	-143	-147	-132	-129	-128	-128	-129
10 MHz		-	-157	-150	-145	-150	-136	-133	-133	-133	-133	
20 MHz	-	-160	-152	-144	-155	-139	-	-142	-142	-		
Integrated Phase Jitter, RMS 12 kHz to 20 MHz; picosecond	1.0	1.0	1.1	1.3	1.1	1.1	1.4	1.1	1.2	1.4		
Control Voltage Function on Pad 1 (VCTCXOs only)												
Control Voltage ($V_{control}$)	$V_{control}$ center and range: $+1.5\text{ V} \pm 1.0\text{ V}$. For both 2.5 V_{DD} and 3.3 V_{DD}											
Frequency Pulling Range	High pull: +8 ppm min. for $V_{control}$ from 1.5 V to +2.5V Low pull: -8 ppm min. for $V_{control}$ from 0.5 V to +1.5V											
Linearity	$\pm 5\%$ typical. $\pm 10\%$ max.											
Transfer Function	Positive Transfer											
Input Impedance	500 K Ω min.											
Bandwidth	10 kHz min. Measured at -3 dB.											

Tri-State function on Pad 2	
Output Enable (OE) Control	70% of V _{DD} (min.) to enable output. CMOS level. Do not leave this pin floating. If no connection is desired, please contact Mercury.
	30% of V _{DD} (max.) to disable the output. Output is high impedance.
Output Enable Time	200 n. sec. max.
Output Disable Time	50 n. sec. max.

Absolute Maximum Rating:

Input Voltage	-0.5 V to V _{DD} +0.5 V
Output Voltage	-0.5 V to V _{DD} +0.5 V
Positive Supply Voltage	4.2 V
Electrostatic Discharge (ESD)	Human Body Model (HBM): Exceeds 2000 V. Class 2 per MIL-STD-1686C
	Machine Model (MM): Exceeds 120 V. Class M2 per MIL-STD-1686C. Note: Power, ground, and outputs are 200 V.
	Charged-Device Model (CDM): Exceeds 2000 V. Class C6 per MIL-STD-1686C

Environmental Performance Specifications

Green Requirement	RoHS compliant, Pb (lead) free per EU Directive 2002/95/EC 6/6 (2002/95/EC) and WEEE (2002/96/EC). Free of halide, cadmium, hexavalent chromium, lead, mercury, PBB's, and PBDE's.
Moisture Sensitivity Level	Level 2 per IPC/JEDEC J-STD-020D.1
Storage temperature range	-55 to +125°C
Humidity	85% RH, 85°C, 48 hours
Fine Leak / Gross Leak	MIL-Std-883, method 1014, condition A / MIL-Std-883, method 1014, condition C
Solderability	MIL-STD-202F method 208E
Reflow	260°C for 10 sec. 2X.
Vibration	MIL-STD-202F method 204, 35G, 50 to 2000 Hz
Shock	MIL-STD-202F method 213B, test condition. E, 1000GG ½ sine wave
Resistance to Solvent	MIL-STD-202, method 215
Temperature Cycling	MIL-STD-883, method 1010
Pad Surface Finish	Gold (0.3 um to 1.0 um) over nickel (1.27 um to 8.89 um)

Part Number Format and Examples:

Example 1: VMQF576D25-192.500-2.0/-40+85;

Example 2: MQF576P33-622.080-2.5/-30+85

VMQF	576	D	25	-	192.500	-	2.0	/	-40+85
MQF	576	P	33	-	622.080	-	2.5	/	-30+85
Main Series "MQF": TCXO "VMQF": VCTCXO	Package Code "576": 7.0x5.0 mm 6-pad SMD	Output Logic "P": LVPECL "D": LVDS	Supply Voltage "33" for 3.3V "25" for 2.5V		The nominal Frequency in MHz. 3 places or more after the decimal.		Frequency Stability. One decimal place.		Operating Temperature Range (°C)

Output OE Function on pad 2 Note: Do not leave this pad floating. If “no-connection” is desired, please contact Mercury.

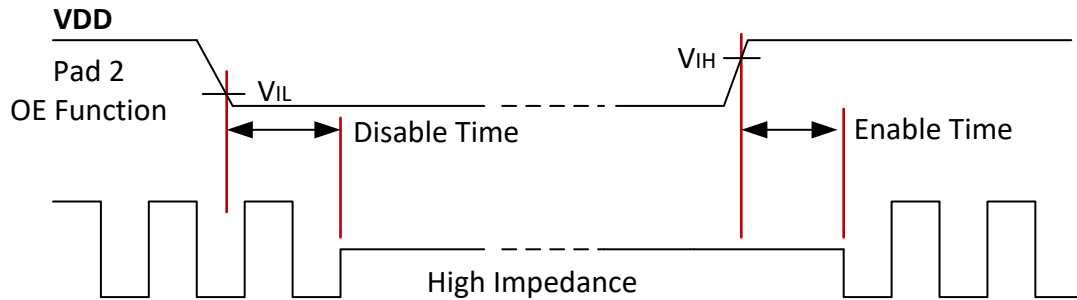

Phase Noise Plot of MQF576P33-156.250 MHz, V_{DD} = +3.3V, LVPECL

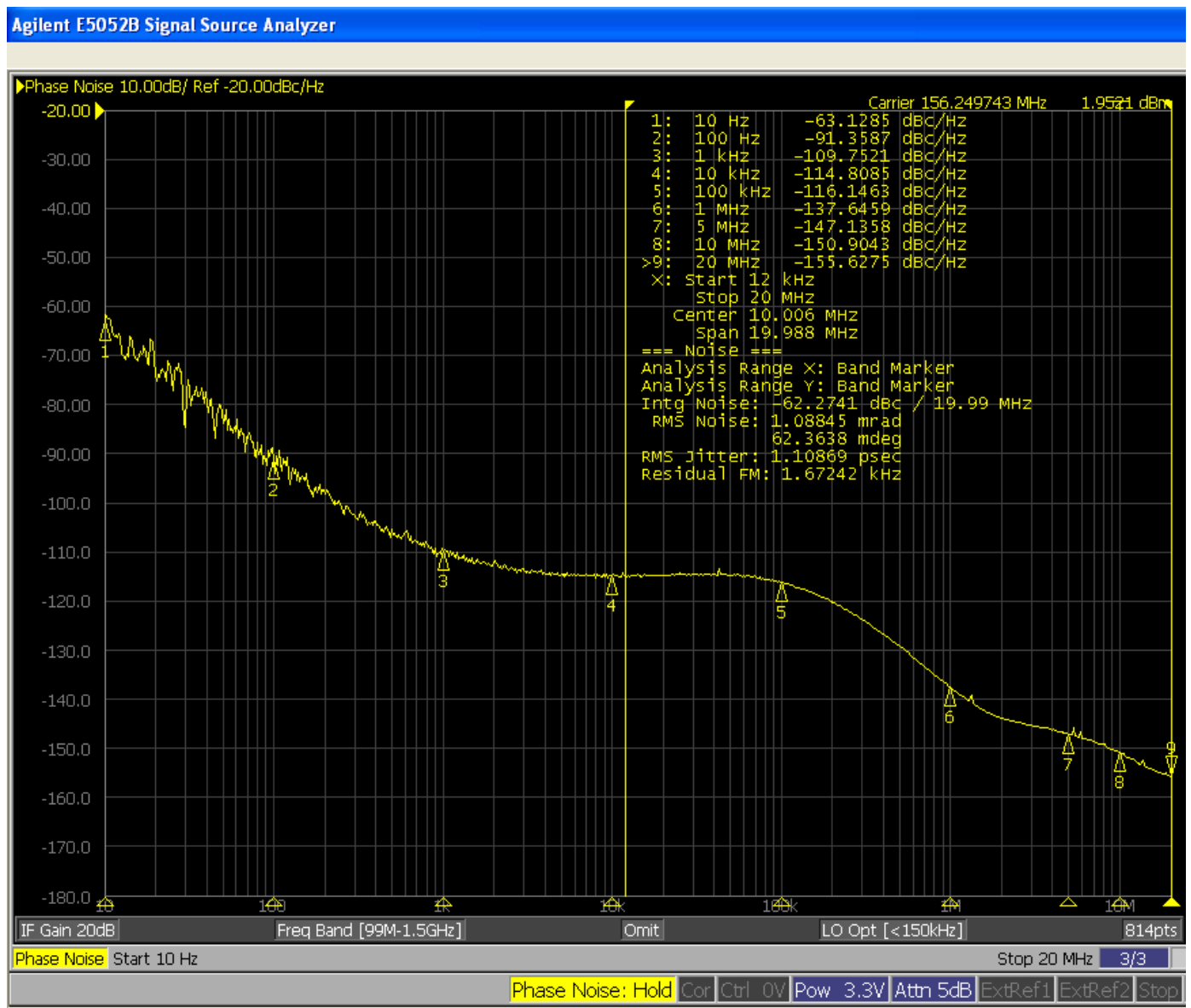

Package Dimensions and Recommended Solder Pad Layout

unit: (mm)

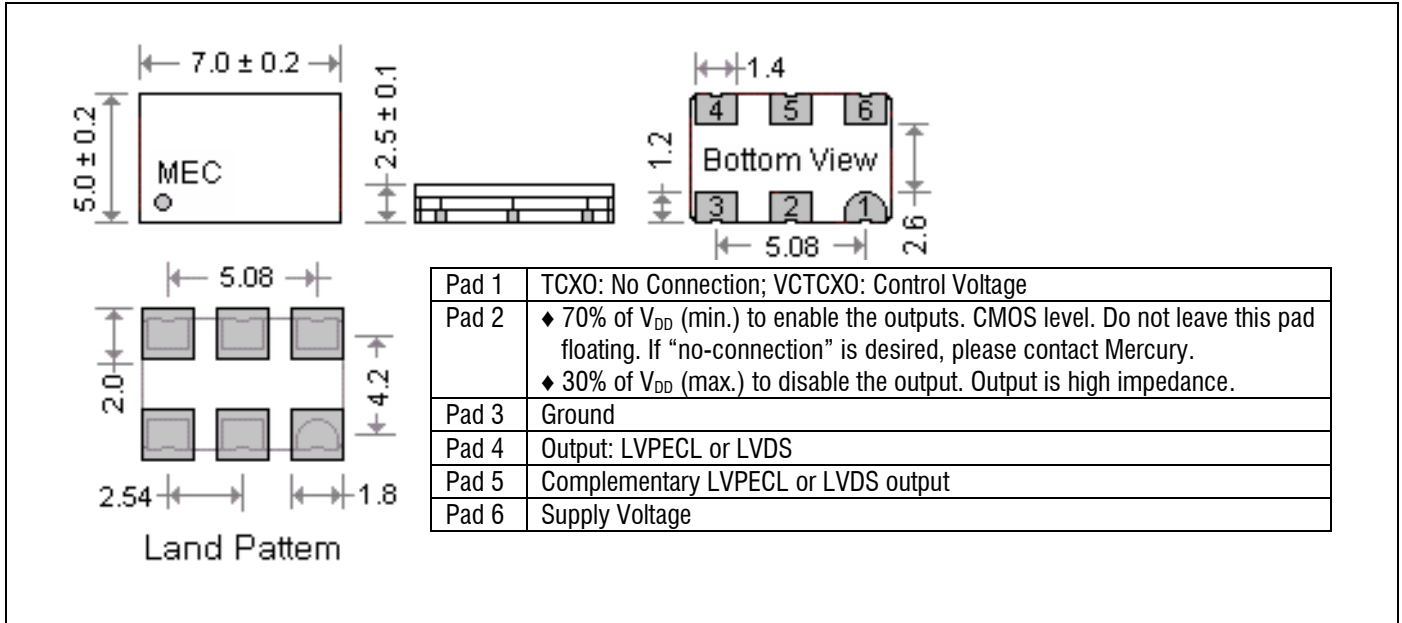

Test Circuits and Output Waveforms

Duty cycle = $\left(\frac{T1}{T2}\right) * 100\%$. Measured at 50% V_{DD}

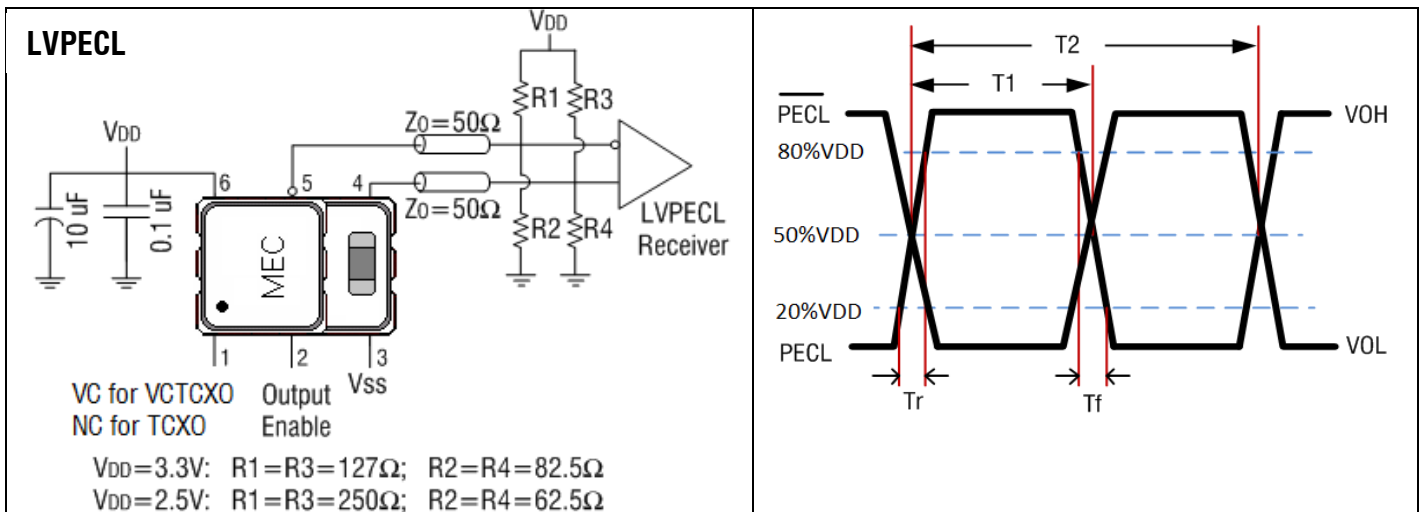

LVDS

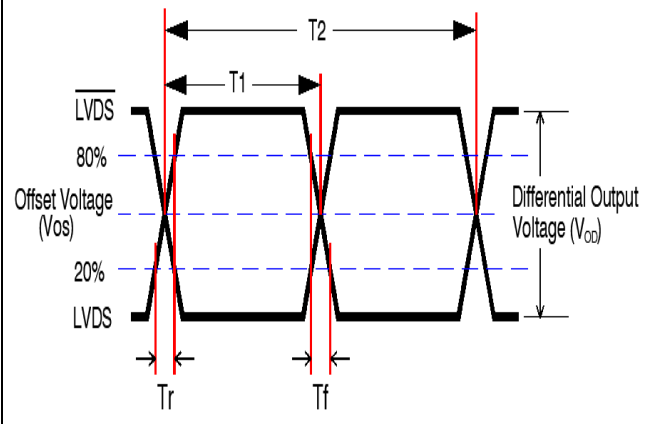
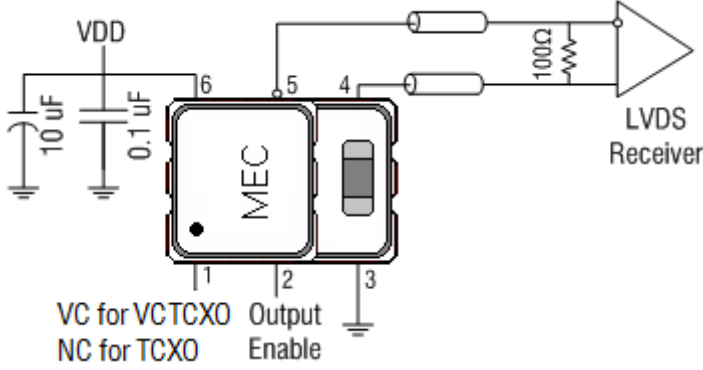

Recommended Solder Reflow Profile (per IPC/JEDEC J-STD-020D.1)

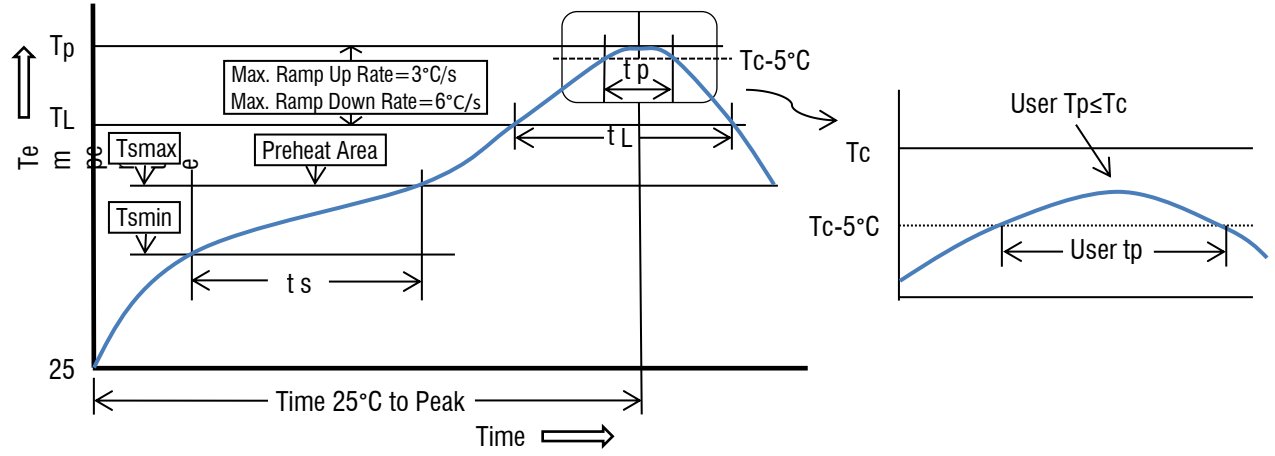

Profile Feature	Sn-Pb Eutectic Assembly	Pb-free Assembly
Preheat/Soak		
- Temperature min. (Ts min.)	100°C	150°C
- Temperature max. (Ts max.)	150°C	200°C
- Time (ts) (Ts min. to Ts max.)	60 to 120 seconds	60 to 180 seconds
Ramp-up rate (TL to Tp)	3°C / sec. max.	3°C / sec. max.
Liquidous temperature (TL)	183°C	217°C
Time (tL) maintained above TL	60 to 150 seconds	60 to 150 seconds
Peak package body temperature (Tp)	235°C	260°C
Time (Tp) within 5°C of the classification temperature Tc	10 to 30 seconds	20 to 40 seconds
Ramp-down rate (Tp to TL)	6°C / second max.	6°C / second max.
Time 25°C to peak temperature	6 minutes max.	8 minutes max.

All temperatures refer to the topside of the package, measured on the package body surface.